



OWNER'S MANUAL
2024-2025

Welcome to the Scamp family!

We believe you will enjoy many years of camping in your Scamp as so many of our customers have for over 50 years. In writing this guide, we have done our best to include everything you need to get started on your next camping adventure. Further information and helpful videos can be found at scamptrailers.com.



This manual is written to cover all features and equipment available in the Scamp line-up. Some of these items may not pertain to your specific layout or selected options.

CONTACT



MN RES: 218.947.4932
TOLL FREE: 800.346.4962



info@scamptrailers.com



507 State Hwy 371 NW
PO Box 2
Backus, MN 56435

TABLE OF CONTENTS

2	CONTACT INFO
3	TABLE OF CONTENTS
4	HOOKING UP YOUR TRAILER
5	ANTI-SWAY CONTROL BAR
5	BRAKE CONTROLLER
6	BEFORE YOU TRAVEL
7	SETTING UP YOUR CAMPSITE
8	TRAILER DIAGRAM
9	ELECTRICAL SYSTEM
12	LP SYSTEM
13	PLUMBING SYSTEM
15	EQUIPMENT OPERATION AND USE
26	MAINTENANCE AND CLEANING
27	STORAGE
28	WINTERIZATION
29	DE-WINTERIZATION
31	SPECIFICATIONS
32	SAFETY PRECAUTIONS
32	TROUBLESHOOTING
35	WARRANTY
36	ELECTRICAL SYSTEM
37	PLUMBING SYSTEM

HOOKING UP YOUR TRAILER

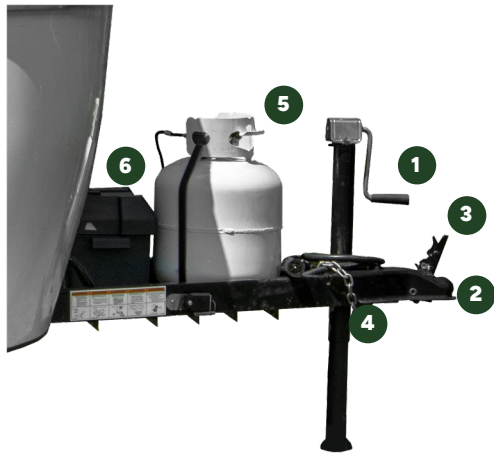

- 1 Manual Tongue Jack
- 2 Coupler
- 3 Hitch Latch
- 4 Safety Chains
- 5 Propane Tank
- 6 Battery

- 1 Raise the front of the trailer using the Manual Tongue Jack (1) to make sure the coupler (2) is above the ball height.
- 2 Back up your vehicle so that the ball is centered under the coupler.
- 3 Lower the trailer onto the ball with the full weight of the trailer. Then retract the tongue jack all the way up into the travel position.
- 4 Latch (3) the coupler and install the coupler pin.
- 5 Install the safety chains (4) and if your trailer is equipped with brakes, install the breakaway switch cable.
- 6 Lastly, plug the trailer wiring into the back of your vehicle and check your lights.



Scamp
VIDEOS & TIPS
HOOKING UP YOUR SCAMP



⚠ WARNING

Uncoupling will cause trailer to come loose from tow vehicle. You must:

1. CHECK that ball LOAD RATING is same as or greater than coupler LOAD RATING.
2. CHECK that ball SIZE is same as coupler.
3. CLOSE COUPLER CLAMP on ball.
4. LIFT coupler upwards to test that it will not separate from ball.
5. LOCK coupler clamp with pin or padlock.

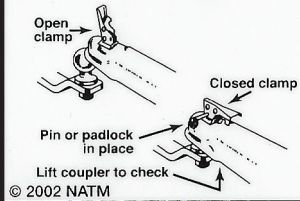

⚠ WARNING

ALWAYS use safety chains. Chains hold trailer if connection fails. You must:

1. CROSS chains underneath coupler.
2. ALLOW slack for trailer to turn.
3. ATTACH chain hooks securely to tow vehicle frame.

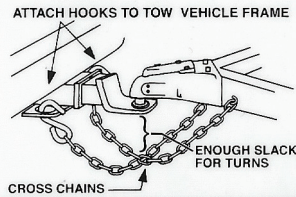

⚠ WARNING

Trailer can roll if it comes loose. Electric safety brake applies when cable pulls pin out of switch box.

1. PULL hard to get pin out of switch box.
2. CHECK brake by PULLING TRAILER with tow vehicle.
3. ATTACH pin CABLE to tow vehicle so pin will be pulled out if trailer separates.
4. Promptly REPLACE pin in switch box.

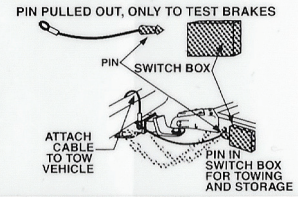

ANTI-SWAY CONTROL BAR

An Anti-Sway Bar will help alleviate trailer sway. If installed: Attach the arm coupler to the 1-1/4" ball on your tow vehicle and insert the pin. Adjust by turning the tension lever clockwise. Start with low tension and increase as needed.

CHECK YOUR TRAILER LIGHTS

Verify all driving lights are functioning. Check right signal, left signal, brake and side marker lights.

SET YOUR BRAKE CONTROLLER

If installed: The trailer mounted Autowbrake controller has been pre-calibrated for your trailer and will automatically brake when needed. The brake power can be adjusted using the remote fob. When you come to a stop, with your foot on the brake, press the up or down buttons to increase or decrease the braking power. During travel you can press any button on the fob to temporarily engage the trailer brakes. If your tow vehicle has a dash mounted controller, follow the instructions for that controller. We recommend starting at level 2 and increase or decrease as needed.

NOTE: If there is a conflict between your dash mount controller you can disable the Autowbrake system (located in the front passenger side, storage or closet area) by removing the fuse.



BEFORE YOU TRAVEL

When packing the trailer, weight distribution should always be kept in mind. Improper distribution may cause the trailer to sway or bounce. Pack items so that they will not migrate or slide around while on the road. Breakable items should be packed securely where they cannot fall or shift. Heavy items should be placed on the floor, over the axle or slightly forward of the axle. It can sometimes be helpful to move the weight further forward and/or drain the rear water tanks. An old rule of thumb is 40% behind the axle and 60% in front.

IF MOVING WEIGHT FURTHER FORWARD, BE AWARE THAT THIS MAY INCREASE THE OVERALL TONGUE WEIGHT OF THE TRAILER.

We recommend you do not tow your trailer with water in fresh water tank. The added weight can break the mounting straps or create a tail sway in your trailer. If you are boondocking, fill your fresh water tank at the last available spot before going off the grid.

PRE-CHILL YOUR FRIDGE

We recommend starting the refrigerator three hours or more before you pack your food. This will ensure that your food will not get warm before the refrigerator reaches temperature.

BEFORE YOU TOW

- Close and lock all windows
- Close all interior doors
- Check that gravel shield clips are secured
- Lock the refrigerator door
- Close glass cook top cover
- Check that all caps and vent covers are closed and secure
- Lower tables into the bed positions
- Close the entry door and lock the dead bolt
- Lift the entry door step into the travel position
- Raise the rear stabilizers until completely retracted
- Check Tire Pressure (Set 6 ply tires to 50 psi., 8 ply tires to 68 psi.)

2" Ball - Recommended Ball Height ideal for level height

(measure from the top of the ball to the ground)

13' = 21"

16' = 21"

19' = 44"*

**Varies based on the size of your truck bed.*

SETTING UP YOUR CAMPSITE

Before you pull in and unhook, you may want to walk around and plot out your campsite. Ideally the trailer should be set up on level ground. Locate any hookups (electrical, water, sewer, etc.) and determine the best place to position the trailer and your camping gear. Look for any posts, trees or other objects that might obstruct the trailer entry door, windows or awning. Planning ahead will save time and make your camping experience more enjoyable.

Once the trailer is in position, check that it is level. You can level side to side by placing blocks under one tire. In the case of the 19', you may also need to adjust or block one of the landing gear legs. After you unhook the trailer and pull the tow vehicle forward, adjust the front jack until the trailer is level front to back. Lower the rear stabilizers until they make firm contact with the ground and chock the tires (stabilizer jacks should not lift tires off the ground).

Hook up any available utilities. These will vary depending on the campsite.

ADDITIONAL GEAR TO CONSIDER

- Potable/Fresh Water Hose
- Water Pressure Regulator for city water hookup
- City Water Filter
- Bubble Levels
- Jack Pads
- Wheel Chocks
- Spare Fuses (AC) and Breakers (DC)
- 30 amp Surge Protector
- 30 amp to 50 amp adapter (use in conjunction with 30 amp fuse or 30 amp surge protector)
- Entry Door Boot Mat or Patio Mat
- Toilet Tank Treatment

(Outside diagram - 16' shown)

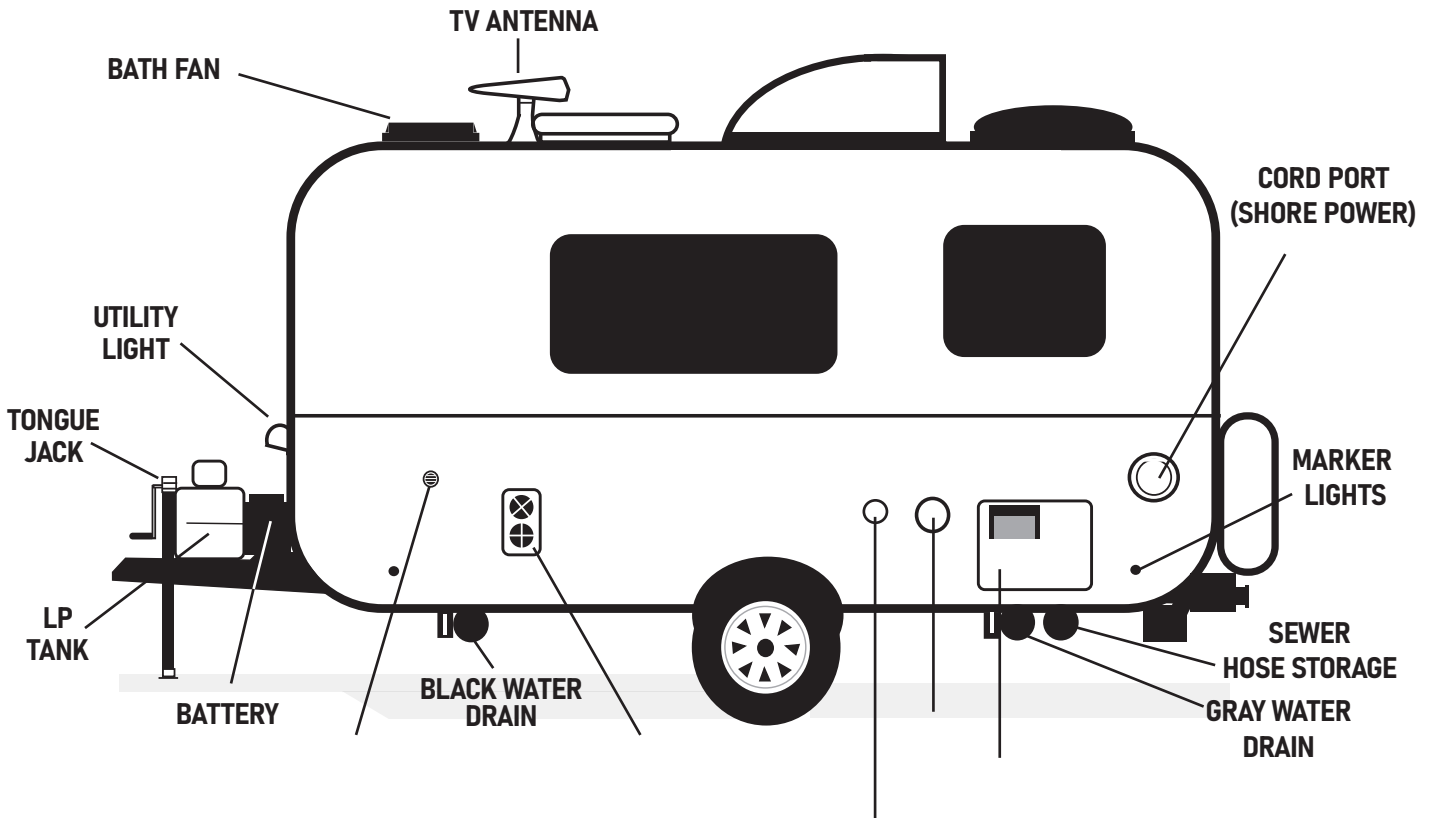
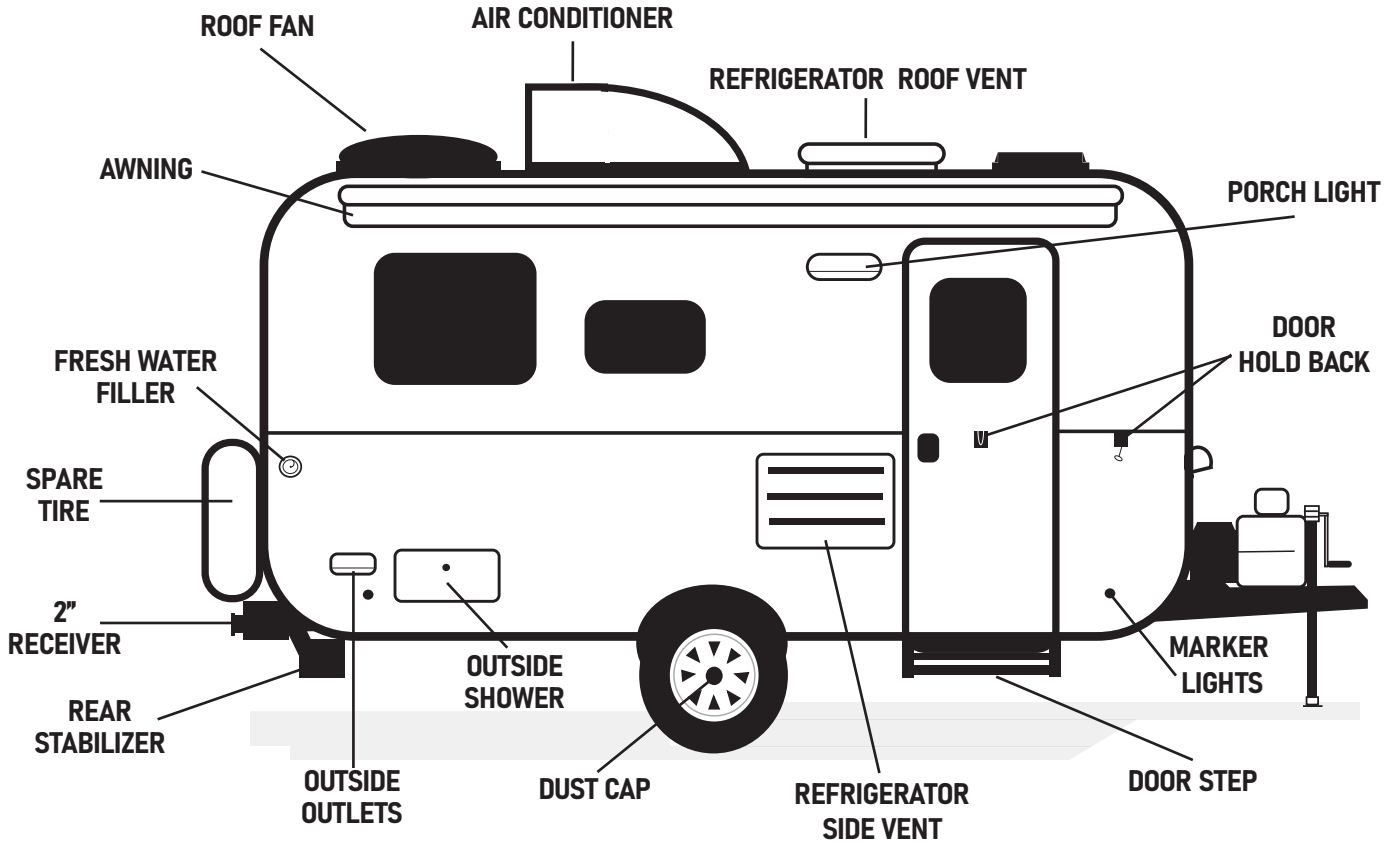

ELECTRICAL SYSTEM

BATTERY DISCONNECT

The battery disconnect switch can be used to isolate the battery from the rest of the electrical system. This is convenient if you are storing the trailer for a few weeks as it will prevent the onboard utilities from drawing down your battery. The disconnect does not interrupt power between battery & charging source.



***Please Note:** The disconnect switch can be used to isolate the trailer from all power sources. This is a convenient way to ensure your battery is not drained by on board utilities.

SHORE POWER

Your trailer is equipped with a 30 amp RV plug called the "Shore Power" hook-up. This can be plugged into a 120V AC, 30 amp service (available at most campsites) or an appropriately sized generator.

You can also plug the shore power into a household 15 amp outlet, using the included adapter, but be aware that the roof air conditioner requires a full 30 amp service (20 amp with soft start).

Running the air conditioner through the 15 amp adapter is NOT recommended.

12V DC SYSTEM/HOUSE BATTERY

Most electrical utilities on your trailer are designed to run on 12V DC (battery). The 12V system is versatile but can only provide power to smaller fixtures and appliances. It will not power the roof air conditioner, or microwave and it will not provide power to the interior household style outlets.

Each of the 12V fixtures and appliances can be powered by the onboard house battery as well as a number of different sources including:

- Your Shore Power hook-up
- Solar array*
- Tow vehicle**
- 12V generator/charger
- 120V generator via shore power hook up

When any of the of these sources are connected, they will also begin charging your house battery.

*Dependent on power consumption, size of solar array and available sunlight.

**Dependent on the tow vehicle wiring and how much power the specific tow vehicle is able to produce.

BATTERY CHARGING

Your trailer has an onboard voltmeter (shown on the right) to aid in determining the battery state of charge. A fully charged battery will have a resting voltage of 12.6V to 12.8V. If there is a load on the battery, it is normal that the voltmeter may display a lower voltage. The battery is generally considered discharged when it reaches 10.5V. Fully discharging may reduce the service life of the battery. For maximum service life, keep the battery topped off as often as possible. If the voltage drops below 10.8V, some onboard equipment such as the furnace, roof fan or refrigerator may cease to function properly. When charging the battery via Shore Power, the onboard charger will deliver between 13.6V and 14.4V. Once the battery is fully charged, the charger will dial down to a 13.2V float voltage.

When charging from your tow vehicle or other external sources, the voltage should be at least 13.6V to provide a sufficient charge to the battery.

FUSE & BREAKER PANEL

Your fuse and breaker panel is mounted on the face of the driver-side rear bench.

BREAKERS IN PANEL (120V)

1. 30a – 120V Main
2. 15a – Refrigerator/Microwave
3. 15a – Converter/Outlets
4. 15a – Water Heater
5. 20a – Air Conditioner

FUSES IN PANEL (12V)

1. 10a – Lights
2. 15a - 12 Volt Outlet
3. 20a – Refrigerator
4. 10a – Furnace
5. 10a – Water Heater
6. 10a - Roof Fan
7. 15a – Fresh Water Pump
8. 15a - Grey Water Pump
9. 15a - Utilities

50 AMP SELF-RESET

This is a separate battery fuse from the one in your panel, it is located inline at the positive battery terminal. Open your battery box cover to access this fuse.

30 AMP CONVERTER FUSES

These two fuses are located on the side of the converter housing. The converter is mounted inside the driver side rear bench.

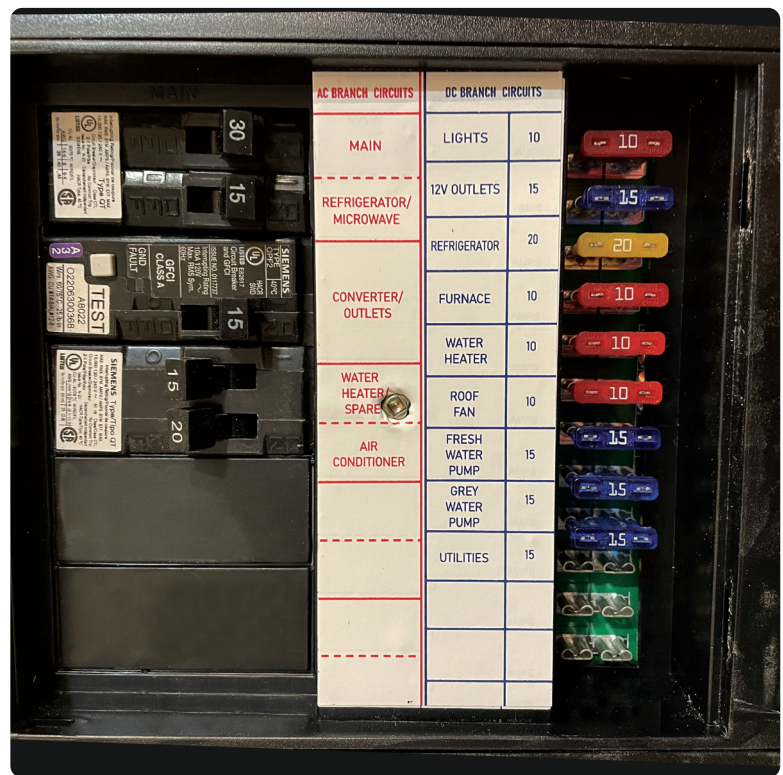

All 12V fuses are standard ATO/ATC fuses. Fuses can blow for a variety of reasons including wiring faults, load spikes (generally from connecting or disconnecting a power source) or defective fuses. Always have spare fuses available.

To see if a fuse is good or bad, look at the filament between the contacts. If this filament is burnt or broken, the fuse has blown and needs to be replaced. A fuse can sometimes appear **good and still be faulty**. If there is any question, try swapping the fuse out to verify that it is indeed working. Since fuses are considered regular maintenance items, the trailer warranty does not cover fuses or service charges that determine a bad or blown fuse to be source of a failure.

ELECTRICAL CONNECTORS

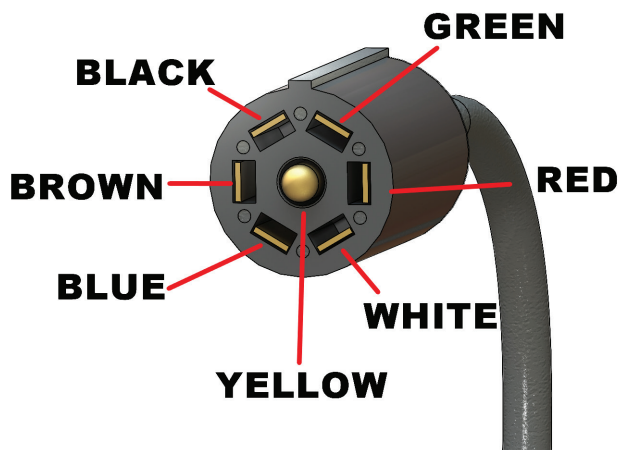

TRAILER END

As viewed from front face of 7-way connector with molded on cable.

- **Green Wire** - Tail Lights/Marker Lights
- **Brown Wire** - Right Turn and Brake Light
- **White Wire** - Ground
- **Blue Wire** - Electric Brakes
- **Red Wire** - Left Turn and Brake Light
- **Black Wire** - Positive (CHARGE/HOT LINE)
- **Yellow Wire** - Auxiliary (Back Up Lights)

*PLEASE NOTE: If you are getting the Autowbrake and having a 7-Way installed on your vehicle, you can let your technician know that the **blue**, brake wiring (needed for a dash controller) is not necessary for the Autowbrake system.

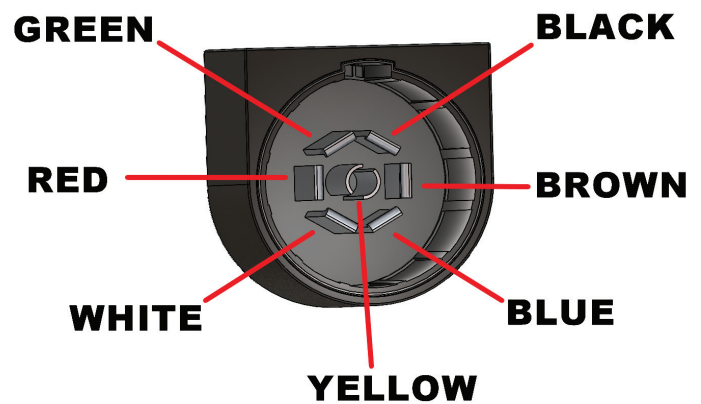

VEHICLE END

As viewed from front face of 7-way connector with sealed cable.

⚠ WARNING

Lights can prevent trailer from being hit by other vehicles. You must:

1. **CONNECT** trailer and tow vehicle electrical connectors.
2. **CHECK** all lights: tail lights, turn signal, and brake lights.
3. **DO NOT TOW** if lights are not working.

side view of
7-way
disconnected



side view of
7-way
connected



LP SYSTEM

Your trailer may be equipped with either single or dual propane tanks. These tanks are 20lb liquid propane cylinders. We selected this tank style because it is the most readily available and most easily exchanged or refilled. To use the propane system, the gas must first be turned on at the tank. Initially, the lines may still be filled with air. Lighting the cook-top can help get the gas moving through the lines and push out the air.

PROPANE TANK GAUGE

The optional single tank gauge can help you in determining how full your cylinder is. The gauge is based on a pressure differential which can fluctuate with the climate. There are markings to assist when reading in different temperature conditions.

PROPANE TANK GAUGE

If you purchased the dual tank system there will be a switchover regulator. This regulator draws from one tank at a time. There is a green indicator on this regulator that will turn red as the last tank begins to run empty. You will then know to switch over to the other tank.

All Scamp models have a CO/PROPANE GAS DETECTOR to alert you of a dangerous situation. It is normal to briefly smell the propane when you first light an appliance. Apart from this exception, you should never be able to smell propane gas inside the trailer.



⚠ DANGER

IF YOU SMELL PROPANE:

1. Extinguish any open flames and all smoking materials.
2. Shut off the propane supply at the container valve(s) or propane supply connection.
3. Do not touch electrical switches.
4. Open doors and other ventilating openings.
5. Leave the area until the odor clears.
6. Have the propane system checked and leakage source corrected before using again.

Ignition of flammable vapors could lead to a fire or explosion and result in death or serious injury.

PLUMBING SYSTEM

WATER SYSTEM TERMINOLOGY

- **FRESH WATER** – This is the water that comes out of your faucets, shower etc. This water is clean and potable (safe to drink).
- **GREY WATER** – This is the dirty wash water from your sink or shower drains. This water is not clean but it is not considered to be hazardous either.
- **BLACK WATER** – This is the waste water from your toilet. This is considered hazardous and must be disposed of properly.

THE FRESH WATER SYSTEM

Your fresh water fixtures can be supplied by either the Fresh Water Holding Tank or the City Water Connection.

FRESH WATER HOLDING TANK AND PUMP

Fill the fresh water holding tank. The port is located at the back corner of the trailer and labeled: **FRESH WATER CONNECTION**. When using water from the holding tank you will need to use the pump.

Turn the pump on by activating the rocker switch labeled: **FRESH WATER PUMP** located on the panel. The pump has a pressure switch and will automatically turn on and off when the faucet is opened and closed. Turn off the pump switch if you do not plan to use the water. Do not turn the pump on if you are connected to city water.

CITY WATER CONNECTION

To use the city water you will need to have a water spigot available at the campsite. Run a clean, fresh water hose from the spigot to the water inlet port. This port is located on the side of the trailer and is labeled: **CITY WATER CONNECTION**. When your trailer is connected to city water it does not fill your fresh water tank.

IMPORTANT NOTE ON CITY WATER USE: Campground water pressure can vary and in some cases exceed the rated pressure of the trailer. Water from campgrounds or garden spigots can also contain silt or other particulates. Either of these issues can damage your pumps, valves and faucets. It is recommended that a water pressure regulator be used inline with the city water connection to keep incoming water **under 60 psi** and protect the trailer plumbing. Both the city water connection and the fresh water pump have built in check valves to prevent water from exiting out the trailer or back-filling into the fresh water holding tank.

GREY WATER SYSTEM

Depending on the options ordered with your trailer, you may have either a Drain Outlet or Grey Water Tank system.

If you have the drain outlet:

The drain outlet is located on the side of the trailer and is labeled as such. This fitting has a standard male garden hose connection. Hook up a hose to direct drain water into a separate storage container for later disposal.

If you have the grey water tank:

The grey water holding tank is drained by use of a dump valve. To empty the grey water tank, drive to the RV dump station. Attach one end of the sewer hose to the tank fitting and place the other end in the dump station tank. Pull the termination valve lever to let the water exit the holding tank.

If you have a shower, you will need to use the drain pump to move the drain water into this tank. The drain pump rocker switch is located on the side of the shower wall (labeled: DRAIN PUMP). This pump does not have an auto shut-off feature. Turn the pump on when using the shower or bathroom sink. Turn off the pump once all water has drained. **Do not run dry.**

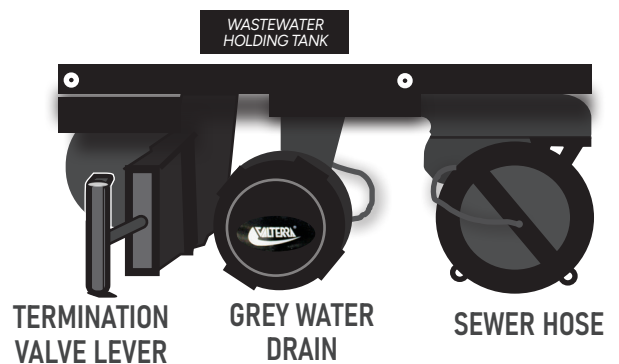

BLACK WATER SYSTEM

The black water sewage holding tank is drained by use of a dump valve. The valve is located on the side of the trailer under the toilet (if applicable). To empty the black water tank, drive to the RV dump station. Attach one end of the sewer hose to the tank fitting and place the other end in the dump station tank. Pull the termination valve lever to let the water exit the holding tank. Once all liquid has been dumped, remove the hose and push the termination valve back in to close it.

EQUIPMENT OPERATION AND USE

ENTRY DOOR LOCK

The door has two lock cylinders:

1. Paddle Handle
2. Deadbolt

To lock the paddle handle:

- Insert the key
- Turn counterclockwise 1/4 turn until key is horizontal, remove key.

To unlock the paddle handle:

- Insert the key.
- Turn clockwise 1/4 turn until key is vertical, remove key.

To lock the deadbolt:

- Insert the key, turn counterclockwise 1/4 turn until the key is horizontal, then turn back until the key is vertical, remove the key.

To unlock the deadbolt:

- Insert the key, turn clockwise 1/4 turn until the key is horizontal, then turn back until the key is vertical, remove the key.

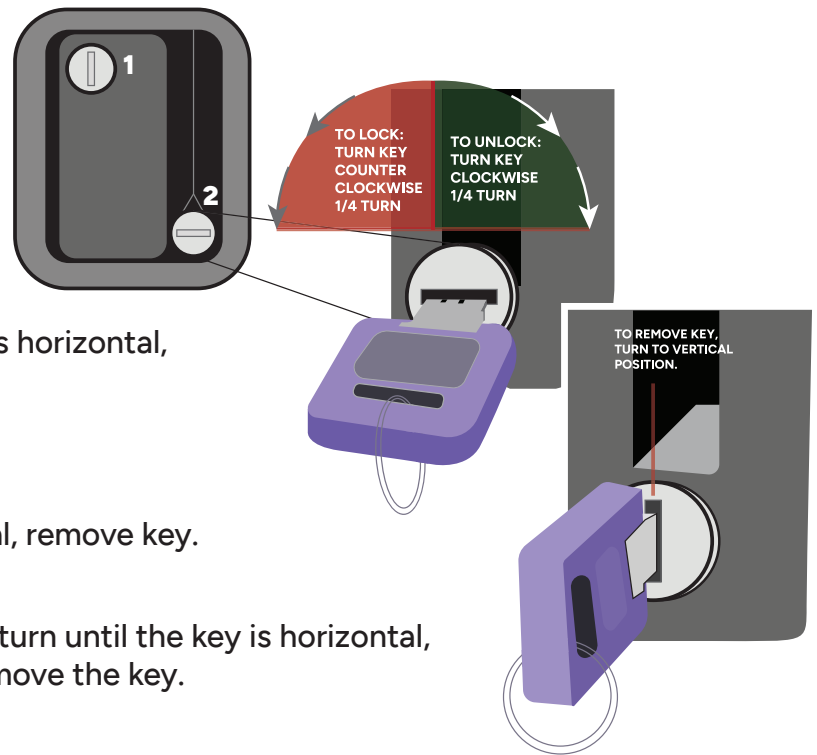

NOTE: To use any propane appliance you must first let gas into the lines by turning the tank valve handle counter clockwise.

FURNACE

Set the thermostat switch to HEAT.

Set the desired temperature using the up and down arrows.

If the selected temperature is greater than the ambient temperature, the furnace will start. If the trailer is very cold, the furnace may overshoot the first cycles. Once the trailer interior begins to warm the temperature will balance out.

2 BURNER COOK-TOP (STANDARD OPTION)

Hold the flame of a long handle grill lighter to the selected burner.

Turn the burner knob to "LIGHT" to ignite. Set desired flame height.

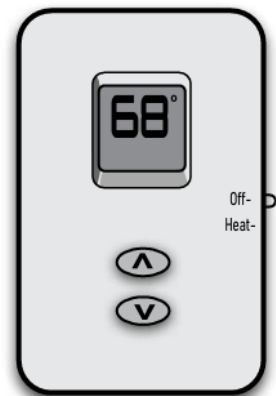

2 BURNER COOK-TOP (UPGRADE OPTION W/ GLASS COVER)

Turn the selected burner knob to the light position (indicated by a picture of a lightening bolt). Push the knob downward and press the auto light button* to ignite the flame. Set desired flame height.

Do not cook on the glass!

*Trailer must be plugged into shore power, or battery disconnect switch must be on.

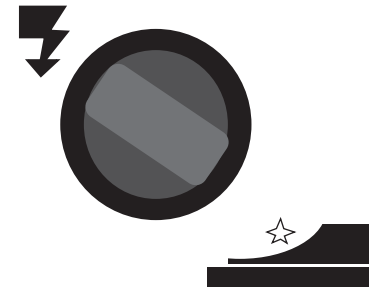
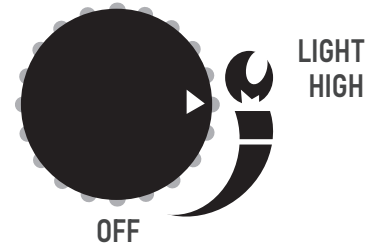

⚠ DANGER

Do not use gas cooking appliances for comfort heating. Can lead to carbon monoxide poisoning, which can lead to death or serious injury.

RANGE

Set the selected burner to "Lite", rotate the spark ignition control until the flame ignites. Turn the knob to the desired temperature.

OVEN

Set the oven control knob to "Pilot". Use a long handle lighter to ignite the pilot flame. Turn the knob to the desired temperature.

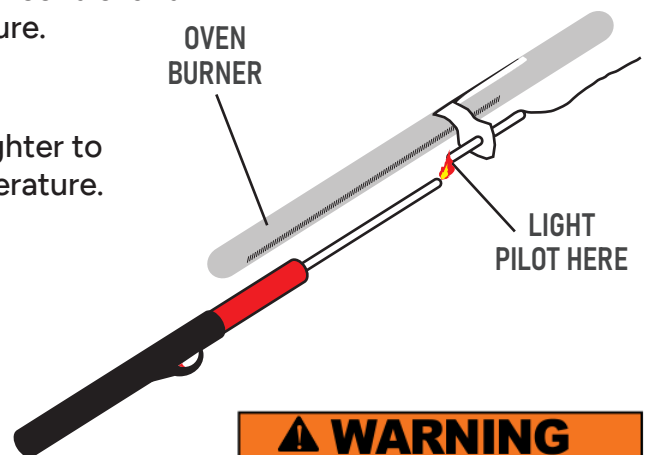

"ON DEMAND" WATER HEATER

Make sure the outside switch (which is located behind the vent on the driver's side) is "ON". From the inside, press the power button on the control panel. The heater will automatically begin to heat. The hot water will be available within a few seconds. You can then adjust the temperature setting using the up/down buttons.

Range: 95° – 124° F.

Very cold, high pressure water may need to be throttled to prevent it from passing through the system before it reaches temperature. There is a flow control valve mounted to the water heater under the rear dinette bench. If necessary, adjust this control to maintain heat. The outside switch should be turned "OFF" when the trailer is not in use. If this switch is left on and the the outside temperature drops below 32° the water heater will switch on to avoid the system from freezing up.

* Please note, that this will draw both from your battery and propane. If you are done using your Scamp Trailer for the season, this would be a good time to winterize your water system.

⚠ WARNING

Gas cooking appliances need fresh air for safe operation. Before operating: Open vents or windows slightly or turn on exhaust fan prior to using cooking appliance. Gas flames consume oxygen, which should be replaced to ensure proper combustion. Improper use can result in death or serious injury.

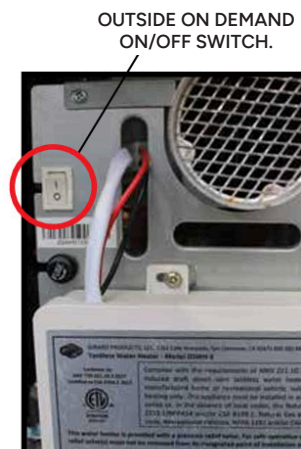

AIR CONDITIONER

The roof air can be run in air conditioning mode or fan only mode as indicated by the control knob. Turn this knob slowly. If you change a setting too quickly it may trigger the overload protection and you will need to wait several minutes for it to auto reset. There is a built in thermostat which can be adjusted by turning the knob toward red for less cold or blue for more cold.

OPTIONAL HEAT MODE

Your air conditioner includes a heat position on the control knob. This setting will only be active if you purchased the optional heater strip.

If you purchased the heat strip option - you may use the heat option on the AC unit.

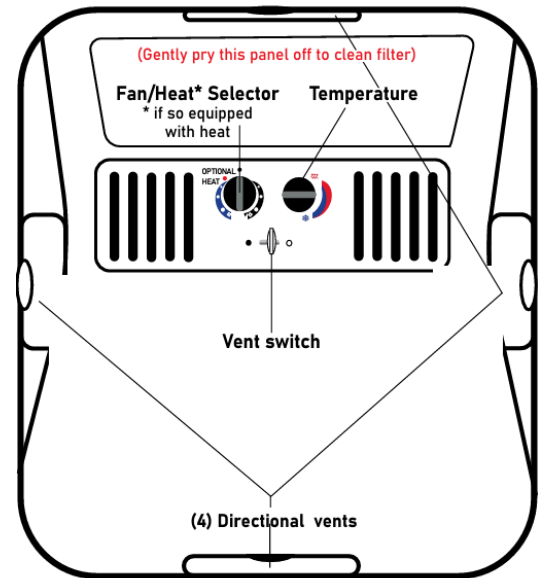

REFRIGERATORS

1.9 CUBIC FOOT REFRIGERATOR: DOMETIC RM2193

PROPANE OPERATION

Turn the LOW-MED-HI knob to MED. Depress the knob while activating the propane ignition button at the same time. Slowly release the knob.

You can visually check the flame by opening the small window cover on the burner housing.

If there is air in the line, this process may need to be repeated until the gas reaches the burner.

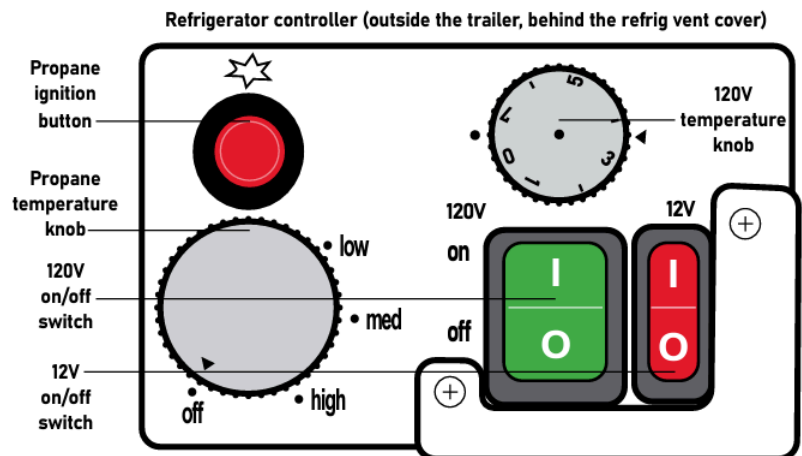

Allow the refrigerator to cool, then use the LOW-MED-HI knob to adjust the temperature.

120 VOLT OPERATION

With the Shore Power hooked up, turn on the green 120V switch. Allow the refrigerator to cool, then use the 1 - 7 knob to adjust the temperature, 1 is least cold and 7 is most cold.

DO NOT turn on the 12V and 120V at the same time.

2.0 CUBIC FOOT REFRIGERATOR: DOMETIC CRX65

Switch the refrigerator on by pressing the On/Off button.

ADJUST TEMPERATURE

Press the temperature selection button repeatedly until the desired temperature level is set.

The more LEDs light up above the button the lower is the temperature level.

To switch from the last level to the first level press the Temperature selection button again.

SETTING THE FAST COOLING FUNCTION (CRX65)

The option of operating the refrigerator using a fast-cooling function allows temperatures suitable for freezing foods to be reached.

- Press the temperature button for longer than 3 seconds.
- The LED above the temperature button lights up.
- Press the temperature button again for longer than 3 seconds to operate the refrigerator in normal mode.

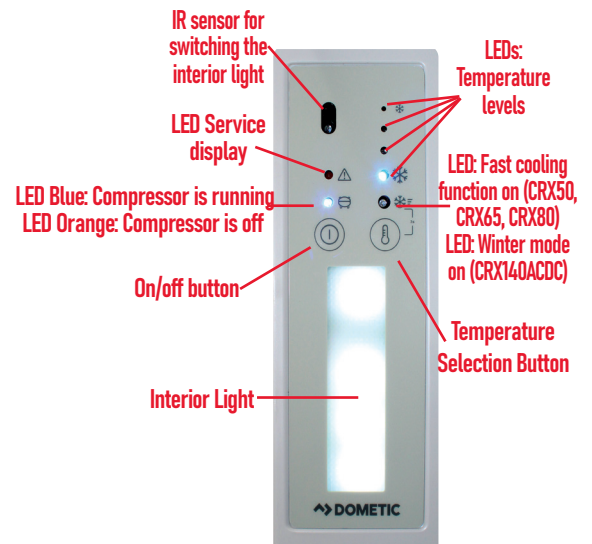

3.0 CUBIC FOOT REFRIGERATOR: DOMETIC RM2354

120 VOLT OPERATION

Press the ON/OFF button until the control panel illuminates. Press the AUTO button and the system will default to AC power when available.

12 VOLT OPERATION

Press the DC button until it illuminates. At this point your refrigerator is drawing off your trailer battery. If you are not charging the battery (through your vehicle or by solar panel) your trailer battery will quickly drain.

PROPANE OPERATION

Press the Auto/Gas until the Gas illuminates. This mode provides LP gas only. The control system activates the ignition system and attempts to light the burner for a period of approximately 45 seconds at two minute intervals. If unsuccessful, the CHECK indicator light will illuminate. To restart GAS operation, press the ON/OFF button to OFF and then back ON. The control system attempts a new ignition sequence.

AUTO MODE

Press the ON/OFF button until the control panel illuminates. Press the AC button until it illuminates. When AC is selected it's getting its power from a house plug in, or shore power.

3.7 CUBIC FOOT REFRIGERATOR: DOMETIC RM8501

PROPANE OPERATION

Press the ON/OFF button until the control panel illuminates. Double press the propane button (indicated by a picture of a flame) until it illuminates. If there is air in the lines, this process may need to be repeated until the gas reaches the burner.



120 VOLT OPERATION

Double press the ON/OFF button until the control panel illuminates. Double press the 120V button (indicated by a picture of a household plug) until it illuminates.

12 VOLT OPERATION

The 12V setting is meant to aid in intermittent cooling while on the road and may not always reach ideal refrigeration temperatures. It is not meant for continuous use. Double press the ON/OFF button until the control panel illuminates. Double press the 12V button (indicated by a picture of a battery) until it illuminates. Do NOT use the 12V setting for regular use, as it will drain your battery.

6.0 CUBIC FOOT REFRIGERATOR: DOMETIC RMD10.5XT

PROPANE OPERATION

Press and hold the control knob until the screen illuminates (about one second)
Turn the knob to highlight the Flame icon.
Press the knob.
The screen will change to display available power settings.
Select the Flame icon.



120 VOLT OPERATION

Press and hold the control knob until the screen illuminates (about one second)
Turn the knob to highlight the Electrical Plug icon.
Press the knob.
The screen will change to display available power settings.
Select the Electrical Plug icon.

12 VOLT OPERATION

Press and hold the control knob until the screen illuminates (about one second)
Turn the knob to highlight the Battery icon.
Press the knob.
The screen will change to display available power settings.
Select the Battery icon.

ADJUST TEMPERATURE

Press and hold the control knob until the screen illuminates (about one second). Turn the knob to highlight the Temp gauge icon. Press the knob. Turn the knob to change the temperature.



TV ANTENNA

Locate the cable plate near your TV and press the black button to send power to the antenna. Go to the antenna control and turn on the slide switch mounted on the side of the panel. Depress the directional control and rotate the antenna. As you rotate, the LEDs will illuminate. The more LEDs, the better the signal strength. There is a small knob next to the LEDs. You can use this to adjust the LED sensitivity to better dial in the signal.

BACKUP CAMERA

Turn on your tow vehicle. The camera will only have power when your lights are on, if your vehicle has auto lights, manually turn on your lights. Pair the monitor with the camera by following the included instructions. Check the camera angle and adjust if needed.

ROOF FAN

The roof fan can be operated by either the face panel or the included remote control. The fan features: 10 speeds, reversible airflow and an auto setting which will turn the fan on and off to maintain specified temperature.

AWNING

Hook the awning crank wand into the eyelet at the end of the awning. Turn until the awning extends 2ft to 3ft. Unfold and extend the legs until they meet the ground. Continue opening the awning, you may need to stop and move the legs further out. To close the awning, follow the directions in reverse order. On either end of the shroud there is a red guide "flag" This will retract when the awning reaches the closed position.

Do not use the awning in windy conditions or in heavy rain.



BUMPER RECEIVER

The 2" bumper receiver is rated for 200 lbs and is intended for use only with bicycle or utility racks.

Do **NOT** use the receiver to pull a second trailer.

TOILET

Press down on the pedal to flush.

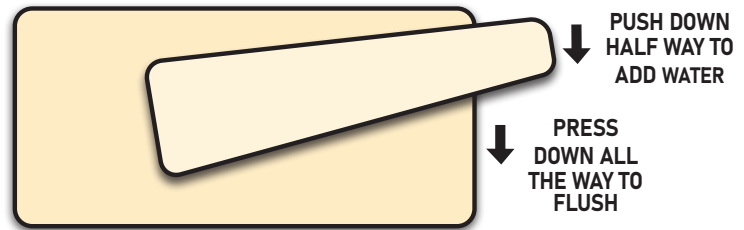

MAKING THE DINETTE AND SOFA INTO A BED

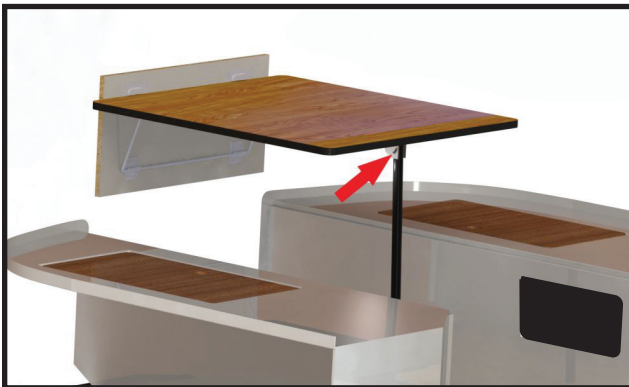

1. While supporting the front of the table with one hand, press the latch release on top of leg.

**Note: Always depress button before folding or unfolding the leg.*

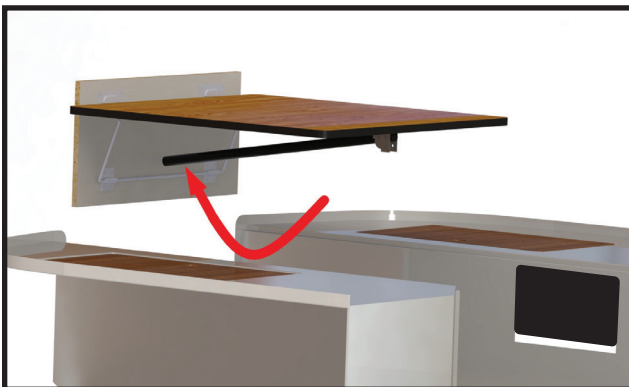

2. Fold leg back under the table.

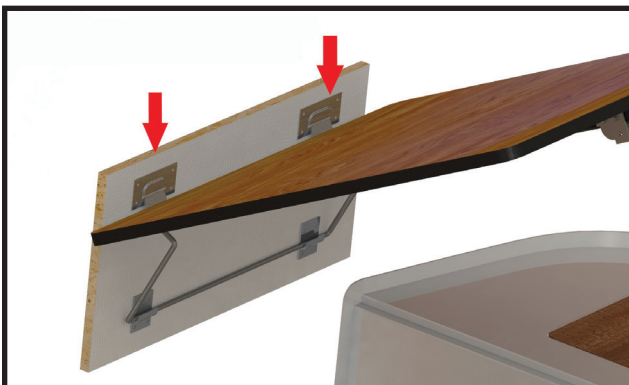

3. Using both hands, lift front of table to let back drop down to disengage the catches.



Scamp
VIDEOS & TIPS
CONVERTING DINETTE TO BED

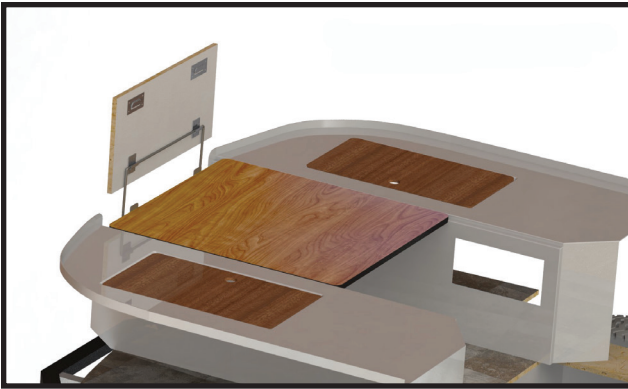

4. Swing out from wall and lower into recess between benches.

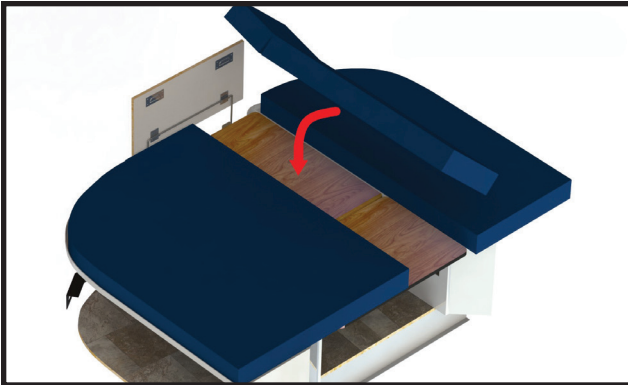

5. Place backrest cushions over table to form the bed.

**Note: To avoid damage to the tabletop, when pulling trailer, always travel with this in the bed position.*

MAKING THE SIDE DINETTE TABLE INTO A BED

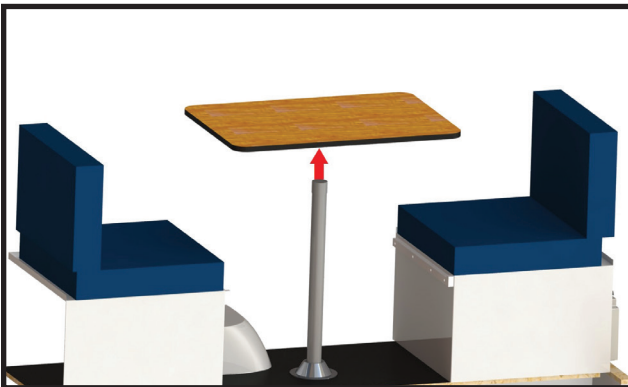

1. While lifting up on the table, make a twisting motion to disengage table from the leg.

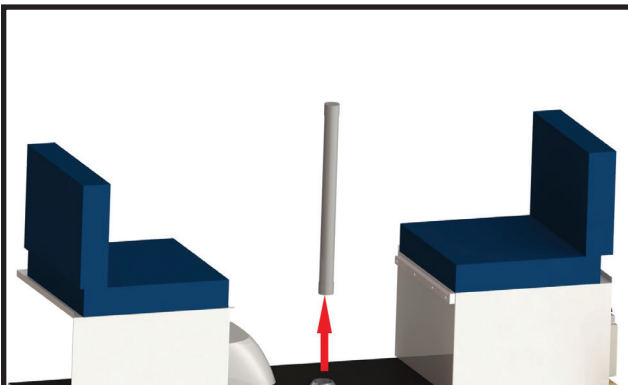

2. Lift and make a twisting motion to disengage the leg from the floor.

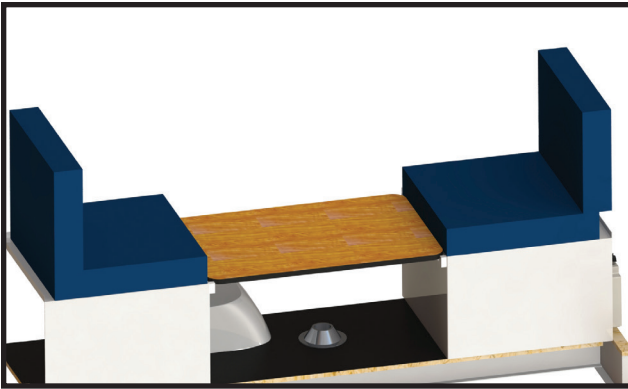

3. Fit table top in recess between benches.

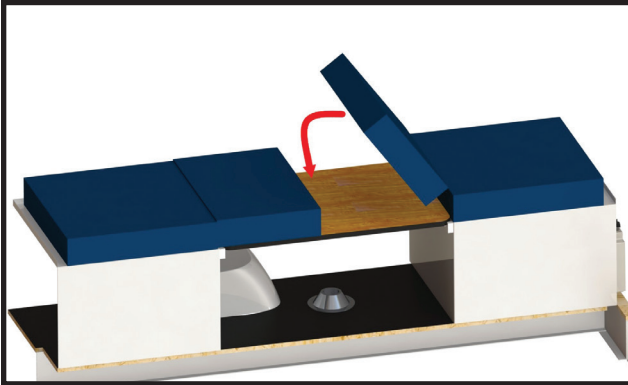

4. Place backrest cushions over table to form the bed.

MAKING THE SOFA INTO BUNK BEDS

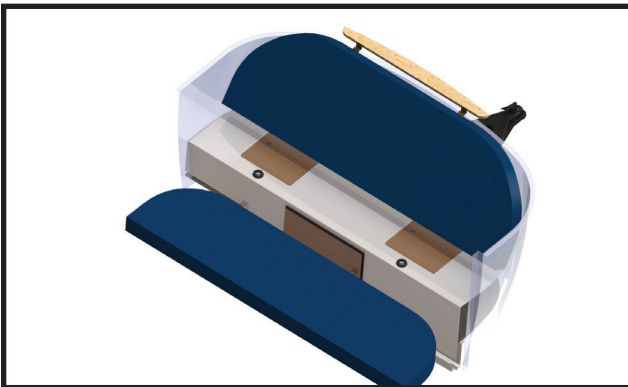

1. Remove the lower seat cushion.

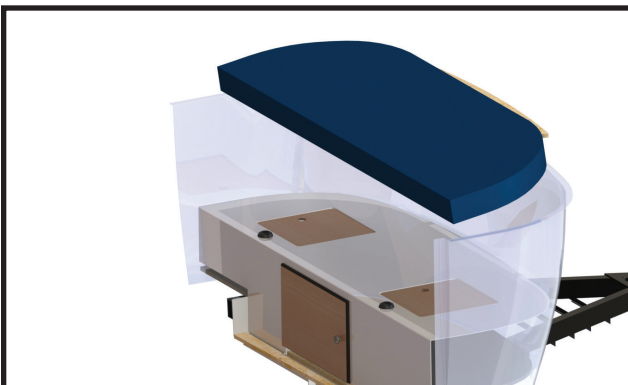

2. Lift the sofa backrest up.

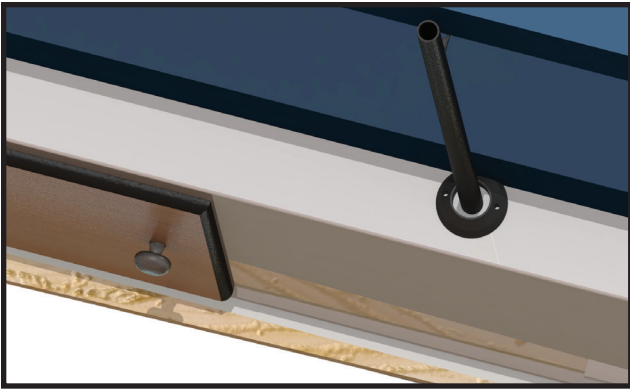

3. While holding the backrest in position, install the bunk posts. Insert the base into the lower bracket.

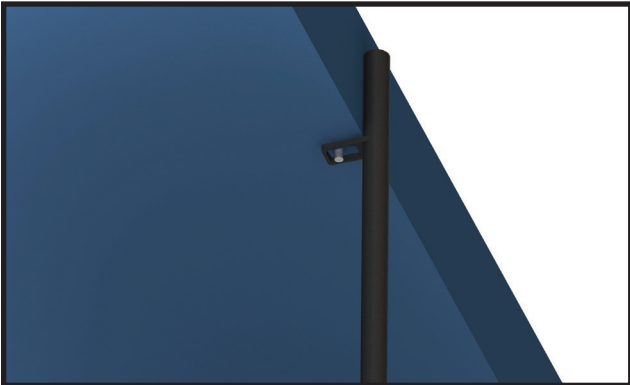

4. Hook the tab under the bunk into the bunk post loop.

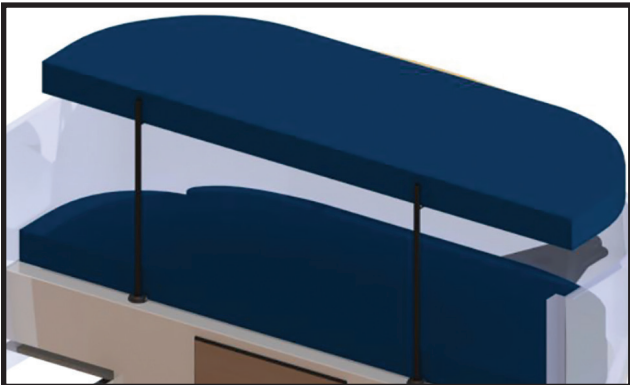

5. Place the lower seat cushion back down to form the lower bed.

** Note: To avoid damage to the bunks, when pulling trailer, always travel with this in the sofa position.*

MAKING THE FRONT DINETTE TABLE INTO A BED

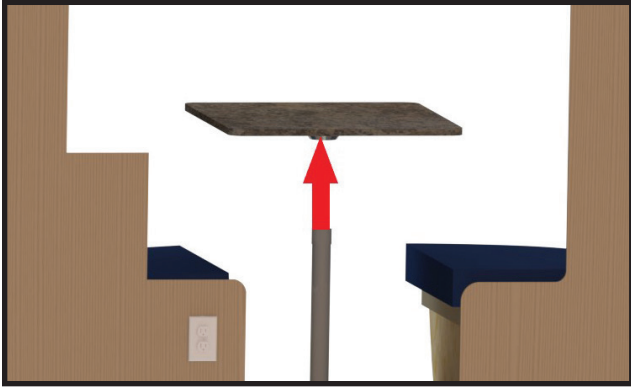

1. While lifting up on the table, make a twisting motion to disengage table from the leg.

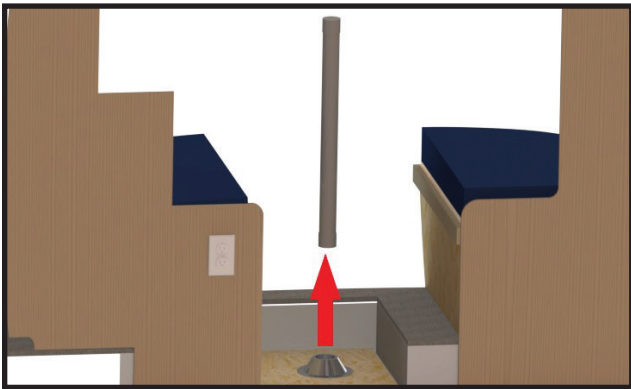

2. Lift and make a twisting motion to disengage the leg from the floor.



3. Fit table top in recess between benches.

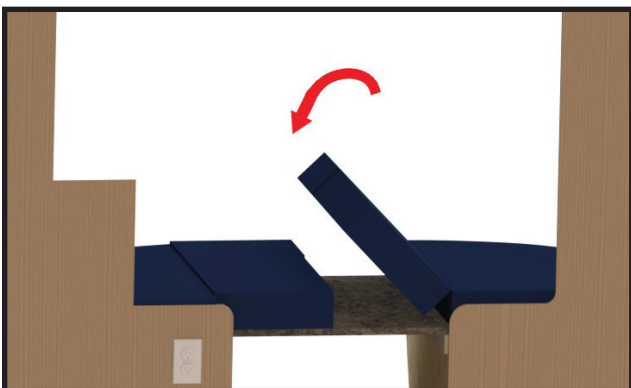

4. Place backrest cushions over table to form the bed.

MAINTENANCE AND CLEANING

BATTERY UPKEEP

The house battery is a wet cell battery and the water level will need to be maintained periodically. How often will depend on battery use and ambient temperatures. Proper safety precautions must be taken when working with the battery. It is recommended that this service be performed by a qualified service technician.

TERMINALS AND CONNECTORS

Regularly inspect all electrical contacts, eyelets, terminals and connectors for corrosion or wear which may degrade the electrical connection and lead to electrical malfunctions.

AXLE BEARINGS

Bearings should be lubed every 5000 miles and visually inspected every 10,000 miles.

LUBRICATION

Remove the rubber cap from the middle of the grease cover on the end of the spindle. Attach your grease gun fitting to the zerk and add grease. Two or three pumps is generally sufficient. It is recommended that the grease be added slowly while rotating the tire. This will reduce the risk of pushing through the grease seal.

VISUAL INSPECTION

Remove dust cap, cotter key, and castle nut. Slowly slide the hub from the spindle. Clean the interior cavity of the hub. Remove bearings from spindle clean and remove old grease from bearings. Visually inspect hub cavity and bearings for discoloration, damage, pitting, or flat spots, and check rolling functionality. Replace parts if needed. Hand pack new grease into the bearings and re-assemble. Add 5 extra pumps (for manual grease gun) or about a thimble sized amount of grease into the chamber.

WATER FILTERS

The fresh water and gray water pumps are equipped with stainless steel reusable debris filters. The fresh water pump filter is located in the passenger side rear bench. The grey water filter is located beneath the trailer under the shower pan. Remove the filter by turning the clear cover counter clockwise. Clean and reinstall.

AIR CONDITIONER FILTER

The roof air conditioner has a reusable fine mesh filter. To remove, gently pry the tabs from the air control panel inside your trailer (see diagram on page 15) and pop the filter from the housing.

WINDOW DRAIN OPENINGS

Most RV windows have drainage openings or “weep holes” in the bottom frame. Check these openings monthly and clean if necessary. If they clog with pollen, leaves or other debris, water may build up in the track and seep into the trailer cabin.

SEALANTS

Inspect all sealant annually around your windows, appliances, doors and vents. If the sealant is damaged, replace immediately. Failure to maintain sealant can lead to serious damage to your trailer with leaking issues.

CABINET DOOR CATCH

The cabinet door roller catches may occasionally shift due to use or vibration. To adjust: Loosen the screws, reposition the catch and tighten screws.

GENERAL CLEANING INFORMATION

WINDOWS	WINDOW & GLASS CLEANERS
FIBERGLASS /GELCOAT	WINDOW OR MULTI-PURPOSE CLEANERS, AUTO OR MARINE WAX AND BODY WAX
WOOD CABINETRY	FURNITURE CLEANERS OR FURNITURE POLISH
CUSHIONS	UPHOLSTERY CLEANERS/ FRESHENERS. CUSHION COVERS CAN BE REMOVED AND MACHINE WASHED. WASH ON COLD/ DELICATE. DRY ON LOW HEAT.
HEADLINER	FABRIC & UPHOLSTERY CLEANERS

STORAGE

SUSPENSION

When storing for prolonged periods, it is a good practice to block up the trailer and relieve stress on the suspension.

To do this jack up the trailer slightly and slide blocks or jack stands under the frame directly behind the axle. The idea is not to lift the trailer completely off the ground but to take the majority of weight off the axle torsion arms. When finished, lower the rear stabilizers to keep the trailer steady. Use blocks under the stabilizer pads if needed.

MOISTURE LEVELS

Humidity can be an important factor depending on your climate. Left unchecked, humid air inside the trailer can condense resulting in water damage, mold and warping. In humid areas, the use of either an absorbent or powered dehumidifier is recommended.

BATTERY STORAGE

The trailer battery should not be left outside in freezing weather for a prolonged period. Doing so may freeze the electrolyte and destroy the battery. Store the battery in a heated space or use a battery maintainer/trickle charger to keep the battery charged and prevent freezing.

WINTERIZATION

To prepare for freezing conditions you will need to drain all water from the trailer and run RV antifreeze through the water system.

EMPTY ALL TANKS

1. First you will need to go to the
2. On the outside, passenger-side of the trailer, there is the fresh water tank petcock valve on the bottom.

Turn the valve to let water drain from the tank (this water will drain out the bottom of the trailer).

RUN ANTI-FREEZE THROUGH THE WATER LINES AND FIXTURES

1. Add RV antifreeze to the fresh water holding tank. Most trailer layouts use 2-3 gallons.
2. Turn on your fresh water pump switch inside the trailer.
3. Go to each fixture and run the cold water side until you see only antifreeze (the anti-freeze is typically colored pink or red)
 - Kitchen sink
 - Bathroom sink
 - Bath shower head
 - Toilet
 - Outside shower head
 - With a tankless water heater, run anti-freeze through the hot water
4. Turn off the fresh water pump
5. Go to the city water connection fitting and gently remove the mesh screen. Push the small button-like protrusion to let water flow out the fitting until you see antifreeze.*

**NOTE: If there is pressure in the line, water and antifreeze may spray out with force.*



ADD ANTIFREEZE TO THE DRAINS

Pump or directly pour antifreeze down the sink and shower drains.

1. Turn on the shower drain pump.
2. Look under the trailer to visually verify that the antifreeze has passed the pump and is traveling down the clear line leading back to the grey water tank.
3. Turn off the shower drain pump.
4. Open the dump valves and drain any excess water and antifreeze.
5. Close all covers and caps.

DE-WINTERIZATION

REMOVE ANTI-FREEZE FROM LINES AND FIXTURES

1. On the outside rear, passenger-side of the trailer, there is the fresh water tank petcock valve on the bottom. Turn the valve to let antifreeze drain from the tank (this will drain out the bottom of the trailer, place a bucket underneath to catch the old antifreeze).
2. Add water to the fresh water holding tank.
3. Turn on your fresh water pump switch.
4. Go to each fixture and run water through until you see only clear water and no color (the antifreeze is typically colored pink or red).
 - Kitchen sink
 - Bathroom sink
 - Bath shower head
 - Outside shower head
5. Turn off the fresh water pump.
6. Go to the city water connection fitting and gently remove the mesh screen. Push the small button-like protrusion to let water flow out the fitting until you see clear water.*
7. Drain any remaining water from the tank (this water will drain out the bottom of the trailer).

**NOTE: If there is pressure in the line, water and anti-freeze may spray out with force.*



REMOVE ANTI-FREEZE FROM LINES AND FIXTURES

1. Fill the fresh water holding tank with bleach sanitizing solution (1 cup of bleach to 2 gallons of water).
2. Turn on your fresh water pump switch.
3. Go to each fixture and run water through until you smell bleach.
 - Kitchen sink
 - Bathroom sink
 - Bath shower head
 - Outside shower head
4. Turn off the fresh water pump
5. Let sanitizer sit in the tank and lines for 4 hours then drain.
6. Remove fresh water filter (which is in front of the pump) and rinse.

RINSE LINES AND FIXTURES

1. Fill the fresh water holding tank with clean water.
2. Turn on your fresh water pump switch.
3. Go to each fixture and run water through until you no longer smell bleach.
 - Kitchen sink
 - Bathroom sink
 - Bath Shower Head
 - Outside Shower Head
4. Turn off the fresh water pump.

SPRING CHECKLIST:

1. Battery: Charge your battery, then hook back up to your trailer.
2. Water System: See De-winterization on page 29.
3. Plumbing: Check the plumbing for any leaks.
4. Appliances: Check the gas supply, check the operation of all LP fired appliances. Do a leak test and LP gas operation pressure test annually.
5. Tires: Check your air pressure. Inspect tires for any cracks, foreign objects.
6. Seams and sealants: Inspect seams and sealants for any cracking or separation, reseal if needed.
7. Replace batteries in thermostat, remotes, and check fire extinguishers that they are fully charged.

FALL CHECKLIST:

1. Battery: If storing in a freezing climate, pull all batteries and store in room temperature area.
2. Water System: See Winterization on page 28.
3. Tires: Check tire pressure, fill to manufacturers specs, as noted on sidewall of tire.
4. Seams and sealants: Inspect seams and sealants for any cracking or separation, reseal if needed.

SPECIFICATIONS

120v OUTLETS RATED FOR 10amp SERVICE

12v SOCKETS RATED FOR 15amp SERVICE

GROUP 24 BATTERY 52AH 88 ca/475cca 125 min RESERVE CAPACITY

GROUP 27 BATTERY 66AH 955 ca/650cca 160 min RESERVE CAPACITY

WHEEL LUG NUT TORQUE 90 FT LBS

WHEEL LUG NUT WRENCH SIZE 13/16"

TIRE PRESSURE 6 PLY LOAD C 50psi MAX

TIRE PRESSURE 8 PLY LOAD D 68psi MAX

REAR STABILIZER NUT SIZE 3/4"

ANODE PLUG SIZE 1-1/16"



BALL HEIGHT

**2" Ball - Recommended Ball Height
ideal for level height**

(measure from the top of the ball to the ground)

13' = 21"

16' = 21"

19' = 44"*

**Varies based on the size of your truck bed.*

The 2" bumper receiver is rated for 200 lbs and is intended for use only with bicycle or utility racks. Do **NOT** use the receiver to pull a second trailer. Weight limit on front bunk bed (top bed) 150 lbs.

CARGO WEIGHT*

Please refer to the label on your trailer for your cargo weight.

*weight may vary due to trailer options

NOTE: NEVER EXCEED YOUR TOW VEHICLE'S MAXIMUM TOWING CAPACITY



SAFETY PRECAUTIONS

AT SCAMP TRAILERS, NOTHING IS MORE IMPORTANT TO US THAN YOUR SAFETY. THIS INCLUDES DRIVING/TOWING SAFETY, OCCUPANT SAFETY, OPERATIONAL SAFETY, AND MORE. WHEN YOU ARE DEALING WITH CARBON MONOXIDE PRODUCING APPLIANCES, PROPANE GAS, ELECTRICITY, IT IS CRITICAL THAT SAFETY BECOME YOUR NUMBER ONE PRIORITY IN AND AROUND YOUR SCAMP TRAVEL TRAILER.



The Safety Alert Symbol is used to warn of a potential personal injury hazard. This symbol is used in conjunction with the signal word or can be used alone. This symbol should be used on both product safety labels and in literature which can describe the potential hazard in greater detail.

TROUBLESHOOTING

PROBLEM	POSSIBLE CAUSE	SOLUTION
LOSS OF 12v POWER FROM BATTERY	<ul style="list-style-type: none"> • Disconnect switch is turned OFF • Low battery • Blown 12v fuse (see Breakers and Fuses page 10) • Loose or corroded wiring connection. 	<ul style="list-style-type: none"> • Turn switch ON • Charge Battery • Replace fuse • Secure wiring. Clean or replace any corroded terminals.
LOSS OF 12v POWER OR CHARGE FROM SHORE POWER HOOKUP	<ul style="list-style-type: none"> • Blown 12v fuse (see Breakers and Fuses page 10) • Converter power cable has become unplugged 	<ul style="list-style-type: none"> • Replace fuse • Plug into adjacent outlet/plug into converter
LOSS OF 12v POWER OR CHARGE FROM TOW VEHICLE	<ul style="list-style-type: none"> • Blown 12v fuse (see Breakers and Fuses page 8) • 7 Way connector is loose, dirty or faulty • Inadequate wiring/power outlet from Tow Vehicle 	<ul style="list-style-type: none"> • Replace fuse • Re-seat, clean or replace connector

PROBLEM	POSSIBLE CAUSE	SOLUTION
BATTERY LOSES CHARGE QUICKLY	<ul style="list-style-type: none"> Loose or corroded wiring connection to battery Tow vehicle wiring is not properly isolated and intermittently draws power from battery Battery is not reaching a complete charge before each use. (12.6v to 12.8v) High power consumption or power drain Battery has reached end of service life or has been drained too far and is damaged 	<ul style="list-style-type: none"> Secure terminals, clean or replace any corroded connectors Service tow vehicle Check charge source: Charge voltage should be 13.6v to 14.4v Unplug any high consumption 12v aftermarket accessories. Check for other power drain. Replace Battery
BATTERY FUSE OR MAIN FUSE BLOWS	<ul style="list-style-type: none"> High power consumption or power drain Battery was drained too far before charging Tow vehicle wiring is not properly isolated and intermittently draws power from battery 	<ul style="list-style-type: none"> Unplug any high consumption 12v aftermarket accessories. Check for other power drain Use separate charger to begin charging. Service tow vehicle
BATTERY DOES NOT CHARGE	<ul style="list-style-type: none"> Disconnect switch is turned OFF Blown 12v fuse (see Breakers and Fuses page #) Charge source is not operating correctly 	<ul style="list-style-type: none"> Turn switch ON Replace fuse Check charge source: Charge voltage should be 13.6v to 14.4v. The lower voltage takes more time to charge.
WATER HEATER IS NOT WORKING ON PROPANE	<ul style="list-style-type: none"> Propane tank is empty Battery power is too low to fire ignition Air in the lines Over-temp safety has been triggered. 	<ul style="list-style-type: none"> Refill tank Re-charge battery Run cook-top to help bleed lines Press to reset (located in outside heater panel)
WATER HEATER IS NOT WORKING ON ELECTRIC	<ul style="list-style-type: none"> Shore Power hookup is not receiving power Breaker is in the OFF position Maintenance switch is in the OFF position 	<ul style="list-style-type: none"> Check 30a power source and plug Charge Battery Turn to ON (located in outside heater panel)
REFRIGERATOR ALARM IS BEEPING	<ul style="list-style-type: none"> Low battery power alarm Open door alarm 	<ul style="list-style-type: none"> Turn on Close door tightly. If alarm persists, adjust catch forward.
REFRIGERATOR DOES NOT RUN ON PROPANE	<ul style="list-style-type: none"> Propane tank is empty Battery power is too low to fire ignition Air in the lines 	<ul style="list-style-type: none"> Refill tank Re-charge battery Run cook-top to help bleed lines
ROOF FAN BEEPS	<ul style="list-style-type: none"> Low battery 	<ul style="list-style-type: none"> Charge battery
ROOF FAN RANDOMLY TURNS ON AND OFF	<ul style="list-style-type: none"> Auto-temp feature is activated Low battery Remote control error 	<ul style="list-style-type: none"> Disable auto-temp Charge battery Turn both fan and remote off and back on.
WATER PUMP IS NOT WORKING	<ul style="list-style-type: none"> Clogged filter Air is being pulled into line Blown fuse 	<ul style="list-style-type: none"> Clean filter Tighten fittings Change fuse (see Breakers and Fuses on Page 10)
FRESH WATER TANK IS FILLING FROM CITY WATER	<ul style="list-style-type: none"> Pump check valve is stuck Pump check valve is damaged 	<ul style="list-style-type: none"> Rap lightly on pump to loosen valve Replace pump

PROBLEM	POSSIBLE CAUSE	SOLUTION
CO2/LP DETECTOR BEEP (NOT ALARM)	<ul style="list-style-type: none"> • Low battery • “End of service life” indicator 	<ul style="list-style-type: none"> • Charge battery • Replace detector
BRAKES ARE LOCKING	<ul style="list-style-type: none"> • Brake control is set too high • Brake control is out of calibration • Breakaway switch plunger has been pulled loose • Brake mechanism is out of adjustment 	<ul style="list-style-type: none"> • Lower setting* • Re-calibrate controller* • Re-seat plunger • Have breaks serviced

* If you are having any Autowbrake system issues please call 319-521-2310. For FAQs and more info: <https://getautowbrake.com> * Note: To disable brakes, follow the 7-way wire into the interior of the trailer, pull the fuse in the brake box (see page 4). This will disable the braking system, while maintaining the trailer lights connection.

IMPORTANT LINKS TO HAVE

DOMETIC PRODUCTS (A/C, Refrigerators & toilets): www.dometic.com

FIAMMA AWNINGS : www.fiamma.it

MAXXAIR fans: www.airxcel.com/rv/maxxair

Contoure microwaves: www.contoureusa.com

Suburban Furnace, cooktop and water heaters: www.airxcel.com

ASA Jensen: www.jensen-electronics.com

Honeywell Thermostat: www.honeywellhome.com/us/en/products/air/thermostats/

King Connect Antenna: www.kingconnect.com

Progressive Dynamics converters/fuses: www.progressivedyn.com

Lippert Windows: www.lci1.com

Lippert Axle: www.lci1.com/manufacturing/axles

Stromberg Carlson 19' landing gear: www.strombergcarlson.com

Furrion Backup Cameras: www.furrion.com/collections/cameras

SeaFlo 33 pump: www.seaflousa.com



Eveland's Inc. DBA: "Scamp Trailers" warrants to the purchaser of this recreational vehicle that the components manufactured by Scamp will be free from defects in material and workmanship under normal use for a period of one (1) year after date of sale, whether or not use begins on this date. This warranty is to the first retail purchaser and is NON-TRANSFERABLE.

Manufacturing defects reported to Scamp within the 1 year warranty period, will be either (at Scamp's option) repaired or replaced. In the event a replacement component is no longer available, Scamp may elect to use a component of similar function and quality.

Third party products installed, but not manufactured by Scamp are not covered by this warranty. Such products include but are not limited to: air conditioner, roof fan, toilet, stove, range, water heater refrigerator, microwave, furnace, television, antenna, trailer cover, solar kit, brakes, axle etc. These products are warranted only by the original manufacturer and only if and to the extent set forth in the original manufacturer's warranty. Scamp will not be liable for any damage or loss of any nature with respect to third party products or the failure of any such supplier to perform under its warranty.

SCAMP SHALL IN NO EVENT BE RESPONSIBLE FOR ANY INCIDENTAL, CONSEQUENTIAL, INDIRECT, OR SPECIAL DAMAGES RESULTING FROM A DEFECT IN ITS PRODUCTS. (Some states do not allow the exclusion or limitation of incidental or consequential damages, so the above limitation or exclusion may not apply to you.)

THIS LIMITED WARRANTY IS GIVEN IN LIEU OF ALL OTHER EXPRESS WARRANTIES. AFTER THE LIMITED ONE YEAR WARRANTY HAS EXPIRED, Scamp SHALL NOT BE RESPONSIBLE FOR ANY IMPLIED WARRANTIES, INCLUDING WARRANTIES OF MERCHANTABILITY OR FITNESS FOR A PARTICULAR PURPOSE. (Some states do not allow these limitations, so the above may not apply to you.)

THIS WARRANTY GIVES YOU SPECIFIC LEGAL RIGHTS AND YOU MAY ALSO HAVE OTHER RIGHTS WHICH VARY FROM STATE TO STATE.

SCAMP WARRANTY PROCEDURE

To initiate a claim, contact the Scamp warranty department. Any claim must be made within the warranty period (one year from the date of sale).

In many cases, a quote for repairs will be required prior to a repair authorization. If the claim meets the terms in the warranty statement, a Warranty Authorization will be given. Services or repairs made without authorization will not be reimbursed.

Once authorized the repair must be completed within 60 days and any invoices submitted.

If, after 60 days, the work is not completed, the claim may be re-opened or a second claim may be initiated provided the trailer is still within the initial one year warranty service period.

Follow the instructions given either by the warranty dept or the instructions given by the authorized service center. DO NOT IGNORE THE INSTRUCTIONS AS IT MAY MEAN REJECTION OF THE WARRANTY CLAIM.

Any defective parts must be kept and returned to Scamp (unless otherwise instructed) to receive warranty reimbursement, DO NOT THROW DEFECTIVE PARTS AWAY UNLESS INSTRUCTED TO DO SO.

Products or components covered by their own warranty and sold/installed by Scamp may also need a Warranty Authorization to initiate repairs or receive reimbursement. Contact the product manufacturer for specific details and instructions.

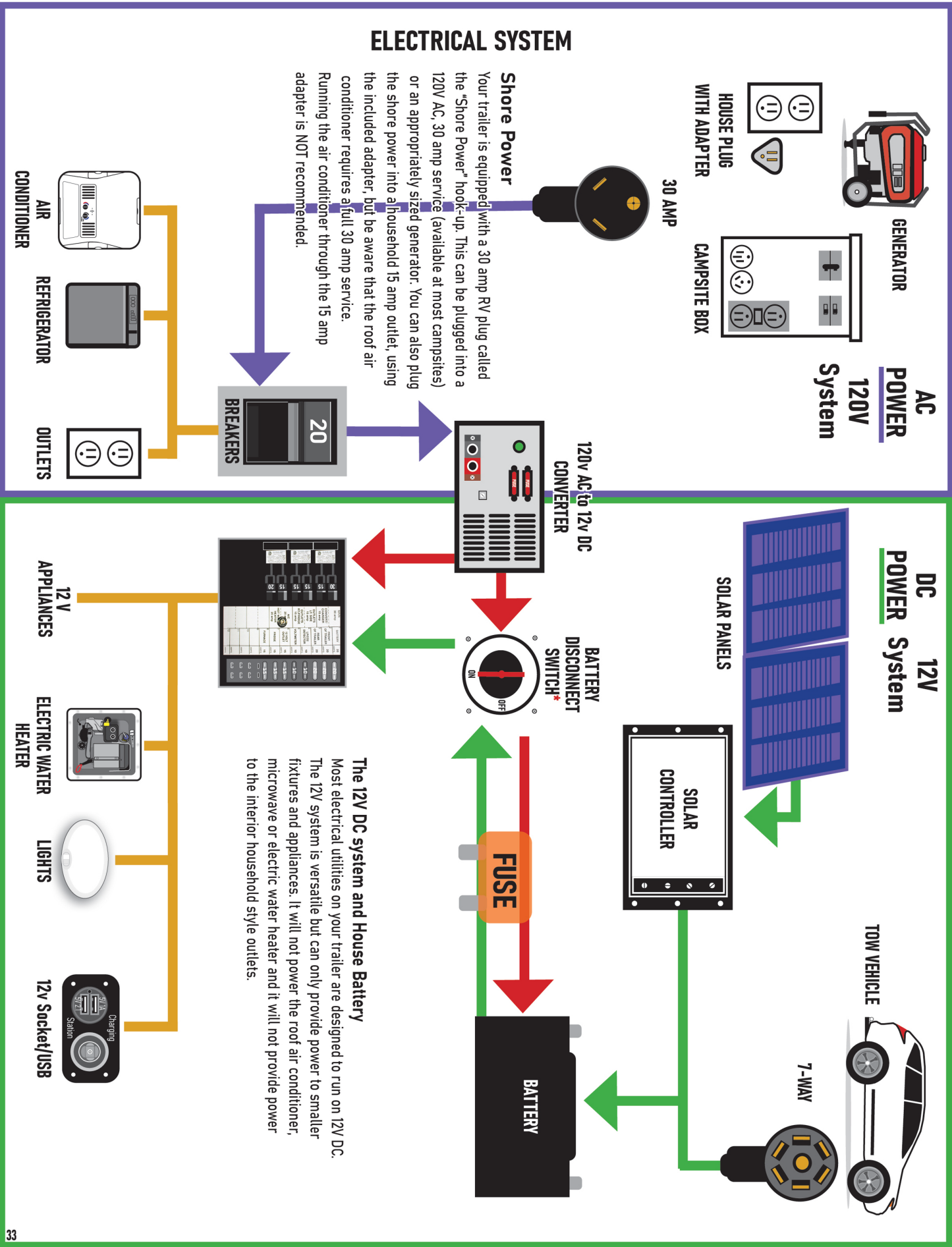

AC POWER 120V System

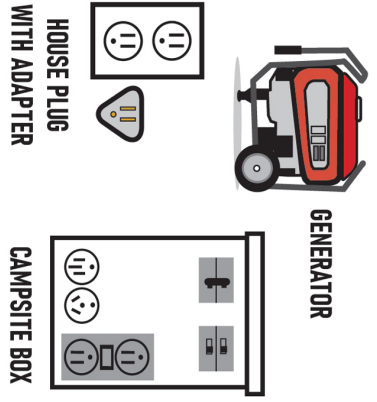

30 AMP

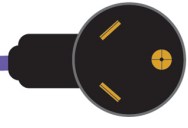

Shore Power

Your trailer is equipped with a 30 amp RV plug called the "Shore Power" hook-up. This can be plugged into a 120V AC, 30 amp service (available at most campsites) or an appropriately sized generator. You can also plug the shore power into a household 15 amp outlet, using the included adapter, but be aware that the roof air conditioner requires a full 30 amp service. Running the air conditioner through the 15 amp adapter is NOT recommended.

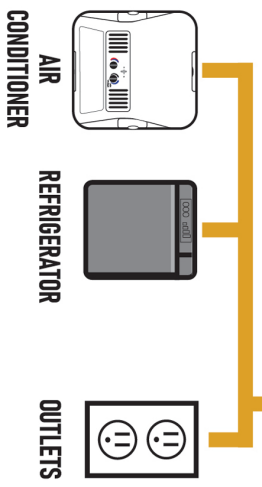
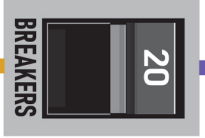

DC POWER 12V System



SOLAR PANELS



SOLAR CONTROLLER

TOW VEHICLE



7-WAY

120V AC to 12V DC CONVERTER

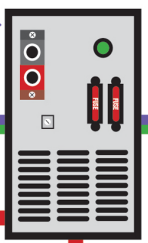

BATTERY DISCONNECT SWITCH



FUSE



BATTERY

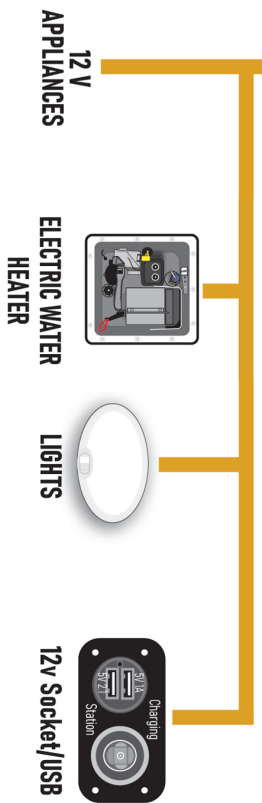
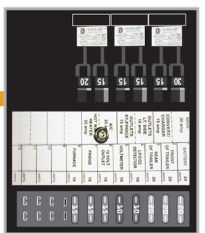

The 12V DC system and House Battery

Most electrical utilities on your trailer are designed to run on 12V DC. The 12V system is versatile but can only provide power to smaller fixtures and appliances. It will not power the roof air conditioner, microwave or electric water heater and it will not provide power to the interior household style outlets.

ELECTRICAL SYSTEM

PLUMBING SYSTEM

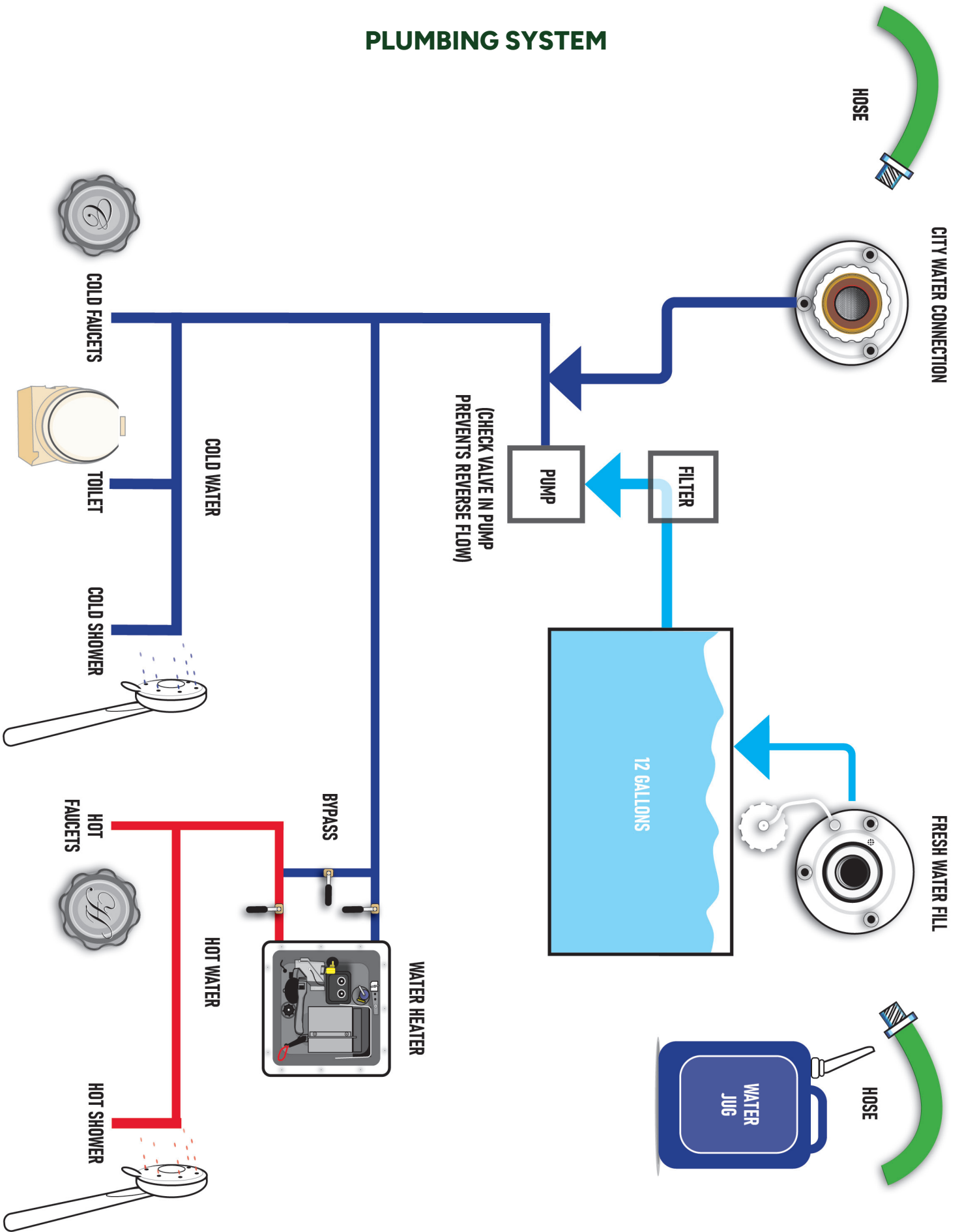

▶ GET OUTSIDE ◀

